

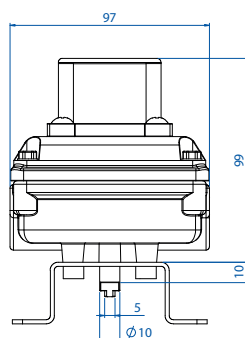

KS1L IN ALLUMINIO CON INDICATORE VISIVO

KS1L ALUMINIUM WITH OPTICAL INDICATOR

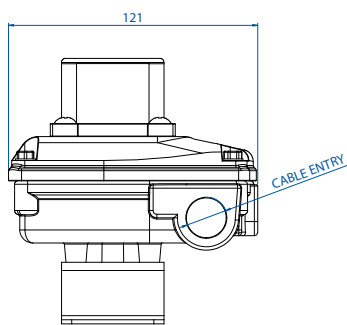
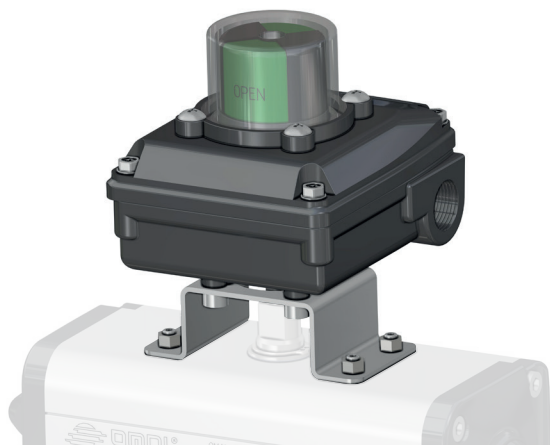

CODICE DI ORDINAZIONE ENCODING

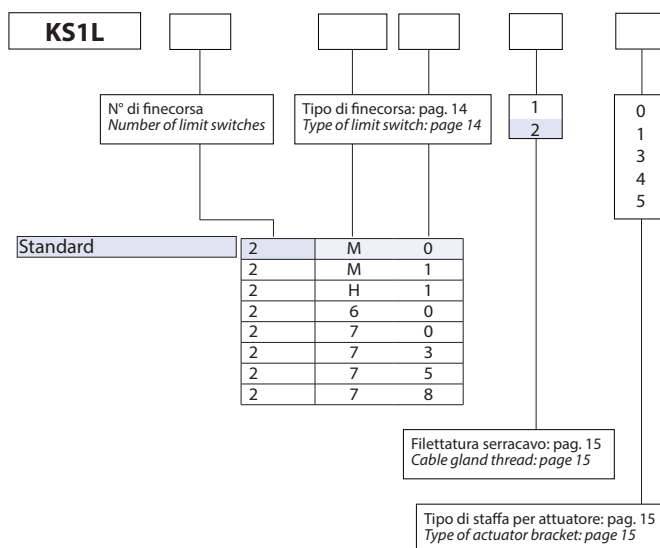

<p>CARATTERISTICHE PRINCIPALI</p> <ul style="list-style-type: none"> Realizzato per verificare facilmente la posizione visiva ed elettrica di ogni valvola anche da lunghe distanze. Costruito a norme VDI/VDE 3845 standard. (EN15714-3) Può contenere al suo interno due finecorsa di segnalazione sia di tipo meccanico "SPDT" che di prossimità. Precisa regolazione delle camme tramite sistema "millerighe". Morsettiera a 8 postazioni. N° 2 connessioni elettriche filettate per serracavo. Temperatura di esercizio STD: da -20°C a +80°C (NBR). Grado di Protezione: IP 67. A richiesta: da -40°C a +80°C (Silicone) 	<p>TECHNICAL FEATURES</p> <ul style="list-style-type: none"> Made to easily verify the visual and electrical position of each valve even from long distances. Built according to VDI / VDE 3845 standards. (EN15714-3) It can contain two limit switches either mechanical "SPDT" or proximity. Precise cam adjustment via "Miller" system. 8 positions terminal block. N. 2 threaded electrical connections for cable gland. Operating temperature: from -20 °C to + 80 °C (NBR). Protection rate: IP 67. On request: from -20 °C to + 80 °C (Silicone).
<p>MATERIALI</p> <ul style="list-style-type: none"> Corpo e coperchio: alluminio pressofuso a basso contenuto di rame rivestito con doppio strato di verniciatura epossidica nera*. Indicatore: policarbonato e ABS. Albero: acciaio inossidabile. Viti: acciaio inossidabile. <p>* A richiesta anche in acciaio inox CF8M.</p>	<p>MATERIALS</p> <ul style="list-style-type: none"> Body and cover: Copper Aluminum Die Coated with Double Epoxy Coating*. Indicator: polycarbonate and ABS Shaft: Stainless steel Screws: Stainless steel <p>* Also in stainless steel CF8M on request</p>
<p>CERTIFICAZIONI</p> <ul style="list-style-type: none"> Dichiarazione di conformità CE a richiesta 	<p>CERTIFICATIONS</p> <ul style="list-style-type: none"> CE declaration of conformity on request



TIPI DI FINECORSIA CONTENUTI NEI BOX KS1L

TYPES OF LIMIT SWITCHES CONTAINED IN BOX KS1L

CODE*	DESCRIZIONE DESCRIPTION	VERSIONE VERSION	COLLEGAMENTO ELETTRICO WIRING DIAGRAM
M0	Microinterruttori elettromeccanici SPDT con contatti argentati (OMRON SS-5) <i>SPDT Electromechanical microswitches with silver plated contacts (OMRON SS-5)</i> Max: 250 Vac 3A - 30 Vdc 3A	Di serie Standard	
M1	Microinterruttori elettromeccanici SPDT con contatti dorati (OMRON SS-01) <i>SPDT Electromechanical microswitches SPDT with gold plated contacts (OMRON SS-01)</i> Max: 125 Vac 0.1A - 30 Vdc 0.1A	A richiesta On request	
H1	Microinterruttori di prossimità magnetici SPDT sigillati ermeticamente (HAMLIN 59140) <i>Hermetically sealed SPDT magnetic proximity switches (HAMLIN 59140)</i> Max: 120 Vac 0.18A - 175 Vdc 0.25A	A richiesta On request	
60	Microinterruttori di prossimità NAMUR 2 fili P+F SJ 3,5 N, NC, tensione nominale 8,2V, (tensione di esercizio 5÷25V) <i>2-wire NAMUR proximity limit switches SJ 3.5 N P+F, NC, nominal voltage 8,2V, (operating voltage 5÷25V)</i> EEx ia IIC T6	A richiesta On request	
70	Microinterruttori di prossimità NAMUR 2 fili P+F NJ2 V3 N, NC, 8V 2-wire NAMUR proximity microswitches P + F NJ2 V3 N, NC, 8V EEx ia IIC T6	A richiesta On request	
73	Microinterruttori di prossimità amplificati 3 fili PNP NO P+F NBB2 V3 E2, <i>3-wire amplified proximity microswitches PNP NO P+F NBB2 V3 E2,</i> 10÷30 VDC; 100 mA - operating current 0 - 100 mA	A richiesta On request	
75	Microinterruttori di prossimità amplificati IFM IS 5026, 2 fili <i>2-wire amplified proximity microswitches IFM IS 5026</i> 5÷36 Vdc; 4÷200 mA	A richiesta On request	
78	Microinterruttori di prossimità NAMUR 2 fili P+F NCB2 V3 NO, NC tensione nominale 8.2V <i>2-wire NAMUR proximity microswitches P + NCB2 V3 NO, NC unamplified, NC, 8.2V</i> EEx ia IIC T6	A richiesta On request	

* La sigla che identifica il tipo di finecorsa usati, compare nel codice del box al 6° e 7° posto.

* The symbol that identifies the type of limit switches used, appears in the code box in the 6th and 7th position



STAFFA DI CONNESSIONE TRA ATTUATORE E BOX FINECORSO

CONNECTION BRACKET BETWEEN ACTUATOR AND LIMIT SWITCHES BOX

KS1L

TIPO DI STAFFA * TYPE OF BRACKET*	DESCRIZIONE DESCRIPTION
0	Connessione NAMUR 25x50x20* (*20=altezza albero attuatore, quota A in figura) Namur connection 25x50x20* (*20=height of the actuator shaft, dimension A as per picture)
1	Connessione NAMUR 30x80x20* (*20 = altezza albero attuatore, quota A in figura) Namur connection 30x80x20* (*20=height of the actuator shaft, dimension A as per picture)
3	Connessione NAMUR 30x80x30* (*30 = altezza albero attuatore, quota A in figura) Namur connection 30x80x30* (*30=height of the actuator shaft, dimension A as per picture)
4	Connessione NAMUR 30x80x30* (*30= altezza albero attuatore, quota A in figura) Namur connection 30x80x30* (*30=height of the actuator shaft, dimension A as per picture)
5	Connessione NAMUR 30x130x30* (*30= altezza albero attuatore, quota A in figura) Namur connection 30x130x30* (*30=height of the actuator shaft, dimension A as per picture)

*La staffa compare nell'ultimo carattere del codice del box per finecorsa. Per ordinare solo la staffa ricorrere al codice OMAL.

*The bracket appears in the last position of the limit switches box code. If you need to order only the bracket, please refer to the Omal code

PER ATTUATORI IN ALLUMINIO FOR ALUMINIUM ACTUATORS

MISURA SIZE	DAN15÷DAN120 SRN15÷SRN60	DAN180÷DAN960 SRN90÷SRN480	DAN1440÷DAN1920 SRN720÷SRN960	DA2880÷DA8000 SR1440÷SR4000
Codice Code	KCPL1015	KCPL1060	KCPL2060	KCPL1A04
Tipo di staffa Type of bracket	1	3	4	5
A (mm)	20	30	30	30
B (mm)	30	40	40	40
C (mm)	30	30	30	30
D (mm)	80	80	80	130

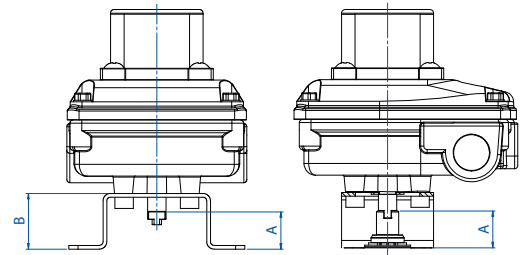

PER ATTUATORI IN ACCIAIO INOX FOR STAINLESS STEEL ACTUATORS

MISURA SIZE	DAN15÷DA30 SRN15**	DAN60 SRN30	DAN120÷DAN960 SRN60÷SRN480	DAN1440÷DAN1920 SRN720÷SRN960
Codice Code	KCPL0015		KCPL1060	KCPL2060
Tipo di staffa Type of bracket	0	0	3	4
A (mm)	20	20	30	30
B (mm)	30	30	40	40
C (mm)	25	25	30	30
D (mm)	50	50	80	80

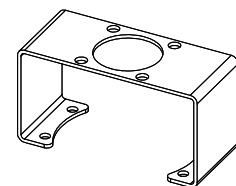
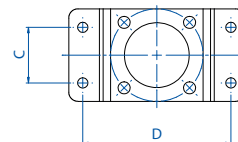

Per "Tipo di staffa" codice 4
For "Type of bracket" code 4

** Previo utilizzo interfaccia per attuatore KBVI4015

** Use connection bracket for actuator: KBVI4015

FILETTATURE DEL SERRACAVO DEL BOX THREADS OF BOX CABLE GLANDS

Tipo di filettatura del serracavo*** Type of cable gland thread***	Descrizione Description	
1	1/2" NPT	A RICHIESTA ON REQUEST
2	M 20x1,5	STANDARD

***La filettatura compare nell'ottavo carattere del codice del box per finecorsa.

***The thread appears in the 8th position of the limit switches box code.