

DEVIATORE A 4 VIE COMANDO PNEUMATICO

4 WAYS DEVIATOR WITH PNEUMATIC CONTROL

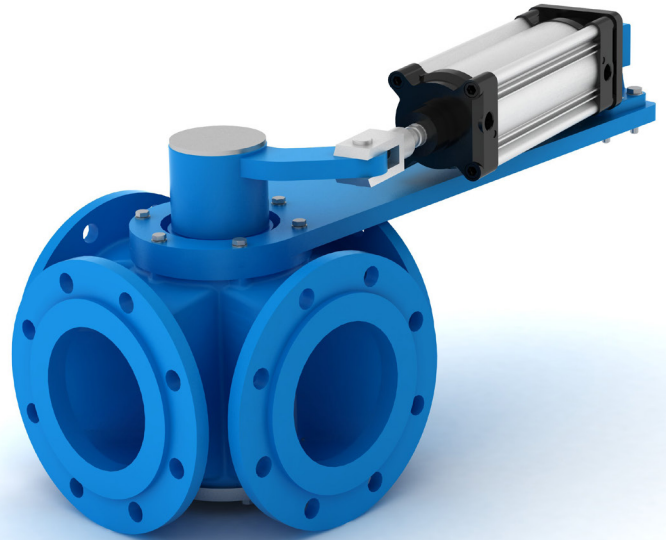
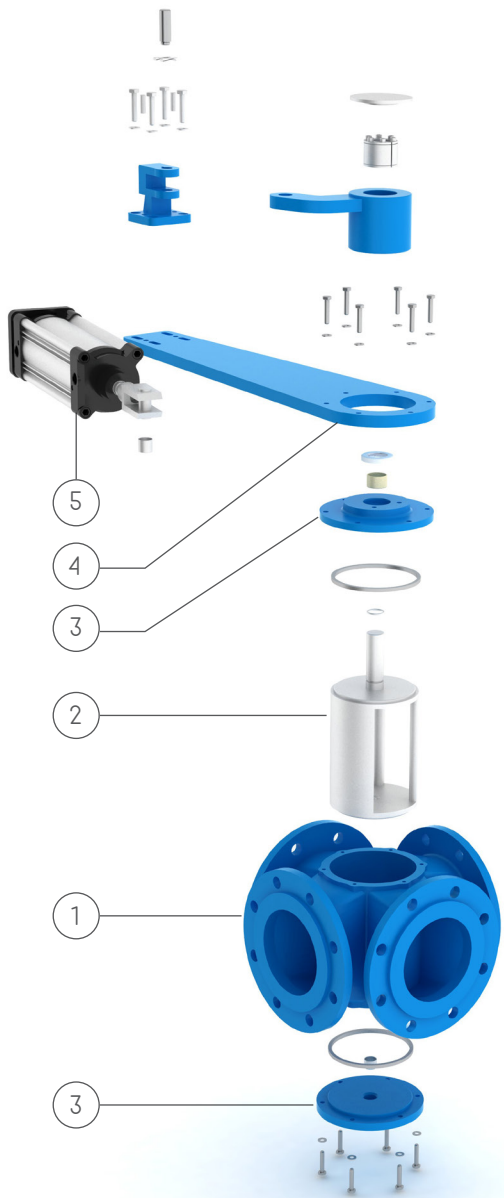

MATERIALI E CARATTERISTICHE / MATERIALS AND CHARACTERISTICS

1	Corpo / Body	GG25, CF8M / GG25, CF8M
2	Rotore / Rotor	AISI 304, AISI 316, / AISI 304, , AISI 316
3	Coperchio / Cover	GG25, CF8M / GG25, CF8M
4	Leva / Lever	Ferro verniciato, AISI 304 / Painted Iron, AISI 304
5	Comando / Control	Cilindro pneumatico doppio effetto / Pneumatic double acting
Tenuta verso esterno / Seal towards the outside		100%
Foratura Flange / Flange drilling		UNI EN 1092 -1 PN 10 (EX UNI2277 - PN10)

DEVIATORE 4 VIE COMANDO PNEUMATICO / 4 WAYS DEVIATOR WITH PNEUMATIC CONTROL

DN		MISURE (mm) DIMENSION (mm)						PESO WEIGHT
inch	mm	Y	H	D	B	C	K	kg
4"	100	180	265	220	110	180	700	46
5"	125	210	310	250	120	200	700	57
6"	150	240	365	285	140	220	700	85
8"	200	295	410	345	170	290	800	120
10"	250	350	450	395	200	340	900	150

