

**VALVOLA MONOBLOCCO UNIDIREZIONALE
CON COMANDO MOTORIZZATO**

*UNIDIRECTIONAL MONOBLOCK VALVE
WITH MOTORIZED CONTROL*

ART 03

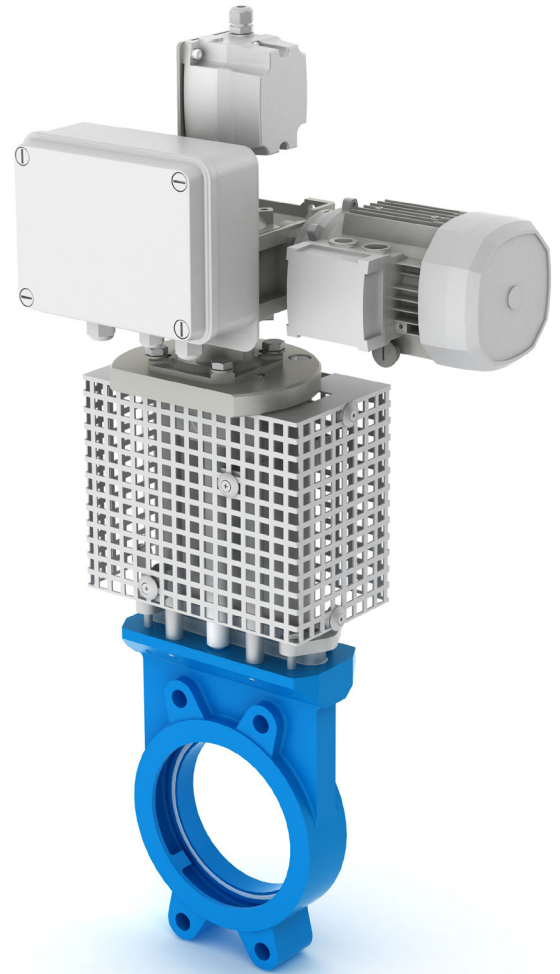
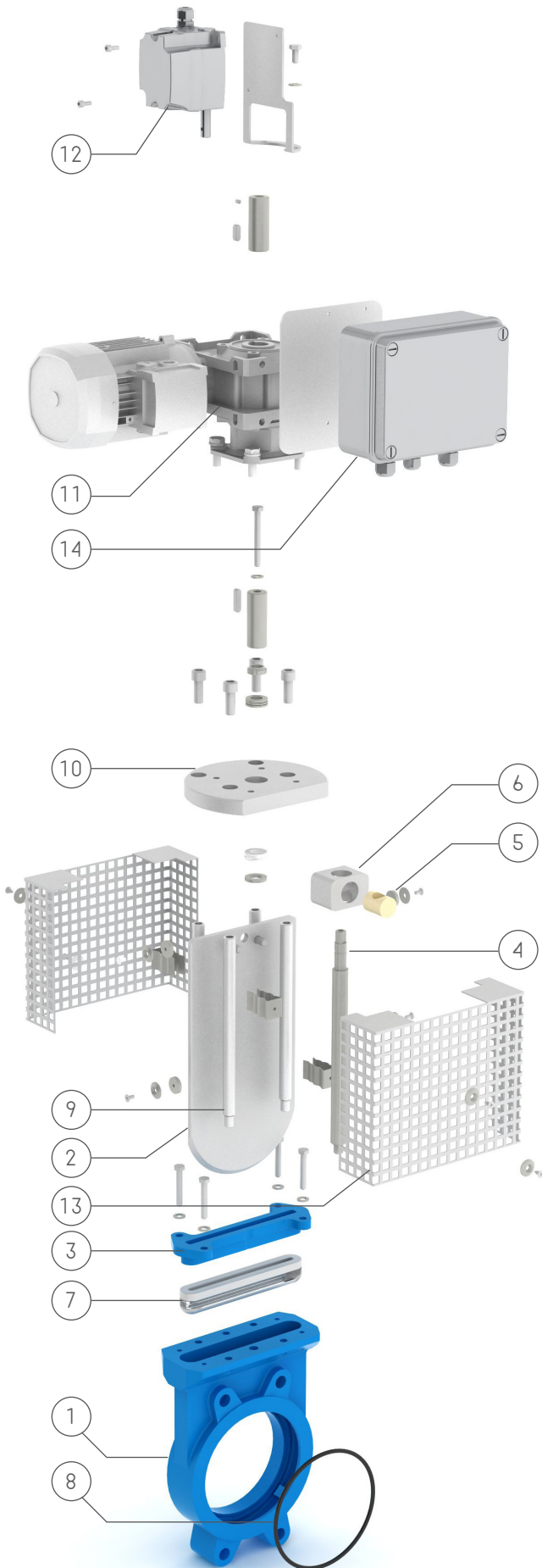

MATERIALI E CARATTERISTICHE / MATERIALS AND CHARACTERISTICS

1	Corpo / Body	GG25, GGG40, CF8, CF8M, BRONZO / GG25, GGG40, CF8, CF8M, BRONZE
2	Paratoia / Gate	AISI 304, AISI 316, Durostat 400, SAF 2205, ACCIAIO ANTIUSURA / AISI 304, AISI 316, Durostat 400, SAF 2205, ANTIUSURY STEEL
3	Premistoppa / Gland follower	Ghisa, Alluminio, Inox / Cast Iron, Aluminium, Stainless Steel
4	Asta filettata NON SALIENTE / NOT SALIENT threaded rod	AISI 304 / AISI 304
5	Chiocciola / Nut	Bronzo / Bronze
6	Blocchetto / Support	Alluminio / Aluminium
7	Baderne / Packings	Treccia teflonata, grafitata, cotonata e silicone / Teflon graphited or cotton braid and silicon
8	OR / OR	NBR, EPDM, FPM, PTFE / NBR, EPDM, FPM, PTFE
9	Colonne / Columns	Ferro zincato, Inox / Iron galvanized, Stainless Steel
10	Piastra supporto / Support Plate	Ferro verniciato, Ferro zincato, Inox / Iron painted, Iron galvanized, Stainless Steel
11	Comando / Control	Attuatore elettrico 230/400V monofase, trifase 50Hz IP55/ Electric motor 230/400V single / three phase th50 Hz IP55
12	Finecorsa / Limit switches	Meccanici / Mechanical
13	Protezione lama / Gate protection	Ferro zincato, Inox / Iron galvanized, Stainless Steel
14	Scheda di controllo coppia	
Passaggio / Passage		Totale / Total
Tenuta verso esterno / Seal towards the outside		100%
Tenuta monte/valle / Upstream/downstream seal		100%
Foratura Flange / Flange drilling		UNI EN 1092 -1 PN 10 (EX UNI2277 - PN10)

Altri materiali e/o versioni a richiesta / Other materials and/or versions up on request

VALVOLA MONOBLOCCO CON COMANDO MOTORIZZATO / MONOBLOCK VALVE WITH MOTORIZED CONTROL

DN		MISURE (mm) DIMENSION (mm)			PESO WEIGHT	PRESSIONE MAX AMMISSIBILE MAX OPERATING PRESSURE
inch	mm	Y	K	H	kg	
2"	50	125	45	567	25	≤ 10 bar
2 1/2"	65	145	45	606	26	≤ 10 bar
3"	80	160	45	630	27	≤ 10 bar
4"	100	180	50	648	28	≤ 10 bar
5"	125	210	50	681	29	≤ 10 bar
6"	150	240	55	733	30	≤ 10 bar
8"	200	295	60	857	42	≤ 8 bar
10"	250	350	60	951	70	≤ 6 bar
12"	300	400	60	1067	78	≤ 5 bar
14"	350	460	70	1149	91	≤ 4 bar
16"	400	515	90	1249	140	≤ 3 bar
18"	450	565	110	1360	190	≤ 2,5 bar
20"	500	620	110	1480	237	≤ 2 bar
24"	600	725	110	1671	310	≤ 1,5 bar
28"	700	840	110	1880	400	≤ 1 bar
32"	800	950	110	2080	480	≤ 1 bar
36"	900	1050	130	2800	730	≤ 1 bar
40"	1000	1160	130	3000	850	≤ 1 bar

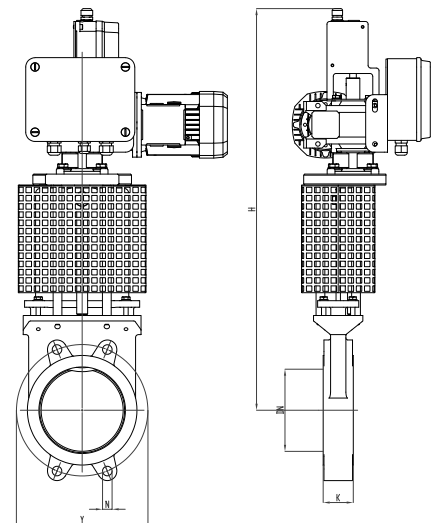

ACCESSORI - ACCESSORIES



ANELLO CEMENTATO

utilizzato per diminuire l'usura del foro di passaggio

TEMPERED RING

used to reduce usury on passage hole

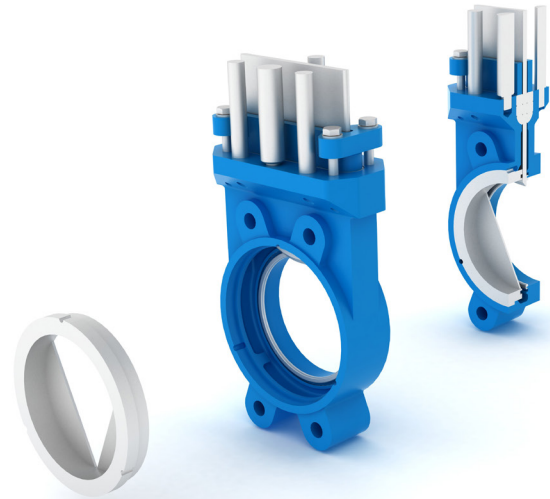

ANELLO CON PASSAGGIO A V

utilizzato per la regolazione del flusso

RING WITH V PASSAGE

used to allow flow regulation

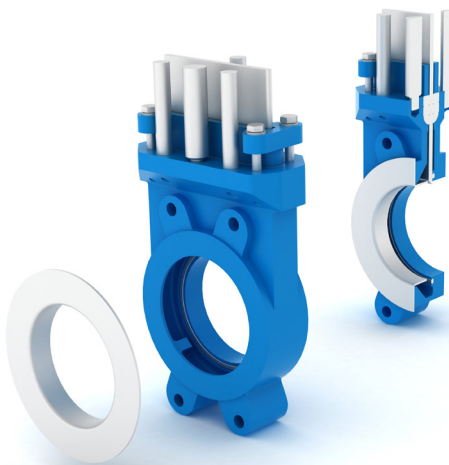

CONO CONVOGLIATORE

utilizzato per proteggere il corpo ed evitare che il prodotto ristagni

CONVEYER CONE

used to protect the body and avoid products penetrations



SISTEMA INSUFFLAZIONE

utilizzato per pulire il vano interno del corpo valvola

INSUFFLATION SYSTEM

used to clean body inside

ACCESSORI - ACCESSORIES



RIDUTTORE CONICO DI MANOVRA

Utilizzato nelle valvole di grosso diametro per facilitare l'apertura e la chiusura
CONIC BEVEL GEARBOX
Used with valves of large diameter to make easier opening and closing



DADI LIMITATORI

Utilizzati per parzializzare l'apertura e la chiusura della valvola
LIMITING NUTS
Used to opening and closing regulation

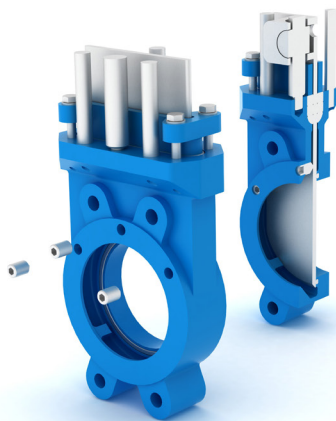

BIDIREZIONALITÀ CON GRANI *BIDIRECTIONAL WITH PLUNGERS*

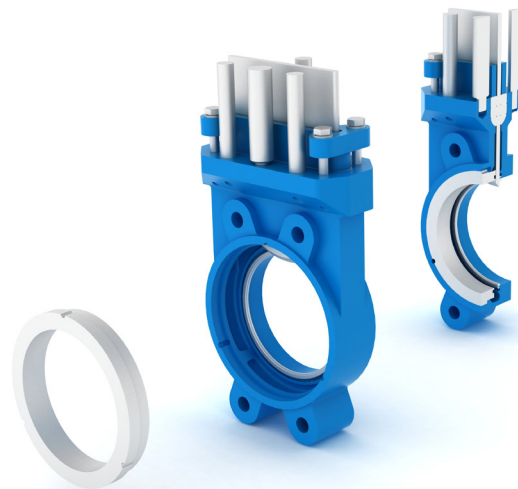

BIDIREZIONALITÀ CON ANELLO *BIDIRECTIONAL WITH RING*

PROLUNGHE - VALVE EXTENSIONS



**PROLUNGA TIPO A:
CON CASTELLO DA FISSARE AL PIANO CALPESTIO**
*KIND A VALVE EXTENSION: ACTUATOR MUST
BE FIXED ON THE FLOOR*



**PROLUNGA TIPO B:
SOLO ASTA CENTRALE**
*KIND B VALVE EXTENSION: ONLY THE
THREADED ROD IS PROLUNGATE*



**PROLUNGA TIPO C:
CON CASTELLO COMPLETO**
*KIND C VALVE EXTENSION: THE SUPPORT OF
ACTUATOR IS TOTALLY PROLUNGATE*

ASSEMBLAGGIO TRA 2 FLANGE / ASSEMBLING BETWEEN 2 FLANGES

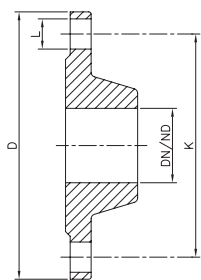

Dettaglio Flangia
Flange detail

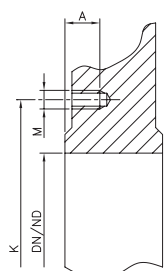

Dettaglio corpo
Body detail

DN		UNI EN 1092-1 PN 10 (Ex UNI EN 2277-67 PN 10)			Necessario per assemblaggio tra 2 flange Equipment for assembling between 2 flanges				
		Diametro esterno External diameter D	Interasse Fori Drilling circle K	Numero Fori x Ø L Hole number x Ø L	Viti numero x M - Lg Screw number x M - Lg	Bulloni numero x M - Lg Bolts number x M - Lg	Profondità Fori Threading depth A	Spessore Flangia Thickness flange	Scartamento Valvola Gauge Valve
inch	mm	mm	mm	no. x Ø	mm	mm	mm	mm	mm
2"	50	Ø 165	Ø 125	4 x Ø 18	8 x M16 - 25	*	11	18	45
2" 1/2	65	Ø 185	Ø 145	4 x Ø 18	8 x M16 - 25	*	11	18	45
3"	80	Ø 200	Ø 160	4 x Ø 18	8 x M16 - 30	*	11	20	45
4"	100	Ø 220	Ø 180	8 x Ø 18	8 x M16 - 30	4 x M16 - 140	11	22	50
5"	125	Ø 250	Ø 210	8 x Ø 18	8 x M16 - 30	4 x M16 - 140	11	24	50
6"	150	Ø 285	Ø 240	8 x Ø 22	8 x M20 - 35	4 x M20 - 150	12	24	55
8"	200	Ø 340	Ø 295	8 x Ø 22	8 x M20 - 35	4 x M20 - 160	12	26	60
10"	250	Ø 395	Ø 350	12 x Ø 22	12 x M20 - 35	6 x M20 - 160	12	28	60
12"	300	Ø 445	Ø 400	12 x Ø 22	12 x M20 - 35	6 x M20 - 160	12	28	60
14"	350	Ø 505	Ø 460	16 x Ø 22	20 x M20 - 40	6 x M20 - 180	14	30	70
16"	400	Ø 565	Ø 515	16 x Ø 25	20 x M24 - 50	6 x M24 - 210	22	32	90
18"	450	Ø 615	Ø 565	20 x Ø 25	28 x M24 - 50	6 x M24 - 230	22	32	110
20"	500	Ø 670	Ø 620	20 x Ø 25	28 x M24 - 55	6 x M24 - 230	22	34	110
24"	600	Ø 780	Ø 725	20 x Ø 30	28 x M27 - 55	6 x M27 - 240	24	36	110
28"	700	Ø 895	Ø 840	24 x Ø 30	32 x M27	8 x M27	24	38	110
32"	800	Ø 1015	Ø 950	24 x Ø 33	32 x M30	8 x M30	24	40	110
36"	900	Ø 1115	Ø 1050	28 x Ø 33	40 x M30	8 x M30	24	42	120
40"	1000	Ø 1230	Ø 1160	28 x Ø 36	40 x M30	8 x M30	24	44	120



VITE
SCREW



BULLONE
BOLT



DN50÷DN80
n°4+4 fori
n°8 viti

DN50÷DN80
n°4+4 holes
n°8 screws



DN100÷DN200
n°8+8 fori
n°8 viti + n°4 bulloni

DN100÷DN200
n°8+8 holes
n°8 screws + n°4 bolts

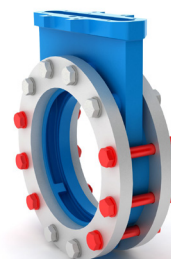

DN250÷DN300
n°12+12 fori
n°12 viti + n°6 bulloni

DN250÷DN300
n°12+12 holes
n°12 screws + n°6 bolts

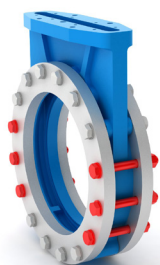

DN350÷DN400
n°16+16 fori
n°20 viti + n°6 bulloni

DN350÷DN400
n°16+16 holes
n°20 screws + n°6 bolts

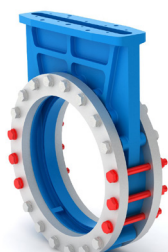

DN450÷DN600
n°20+20 fori
n°28 viti+n°6 bulloni

DN450÷DN600
n°20+20 holes
n°28 screws + n°6 bolts

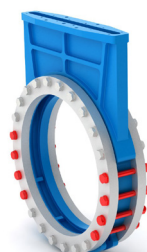

DN700÷DN800
n°24+24 fori
n°32 viti + n°8 bulloni

DN700÷DN800
n°24+24 holes
n°32 screws + n°8 bolts

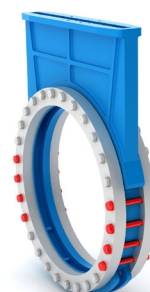

DN900÷DN1000
n°28+28 fori
n°40 viti + n°8 bulloni

DN700÷DN1000
n°28+28 holes
n°40 screws + n°8 bolts